

**Wichtig! Bitte mit der Pflegeanleitung aufbewahren! • Important! Please keep together with care instructions!**  
**Ważne! Proszę przechowywać z instrukcją pielęgnacji! • Внимание! Хранить вместе с инструкцией по эксплуатации!**

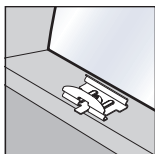

Falzmontage  
Top fixing  
Montaż w świetle szyby  
Монтаж в проем



2,2 mm Ø 2,0 mm Ø 1,5 mm Ø

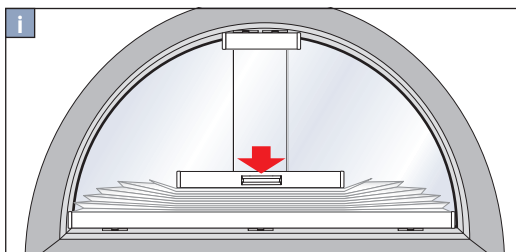
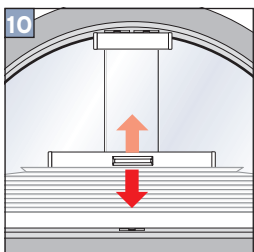
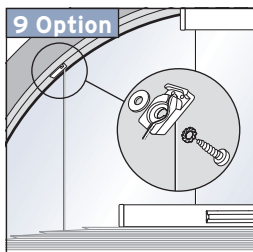
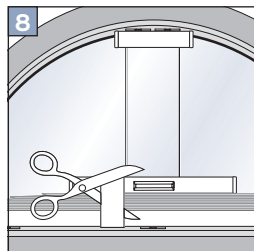
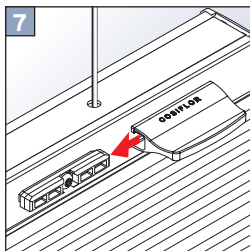
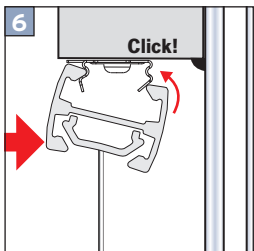
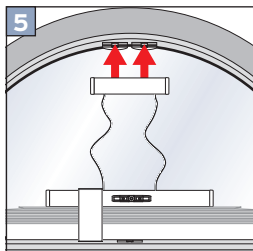
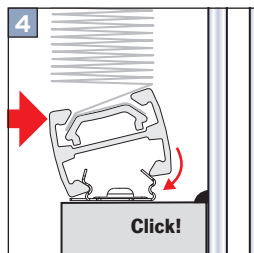
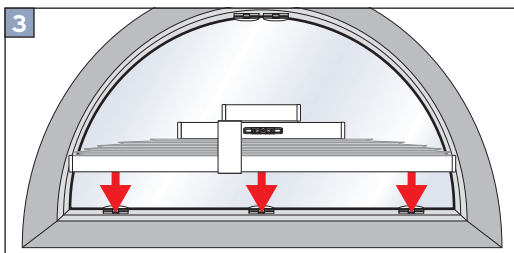
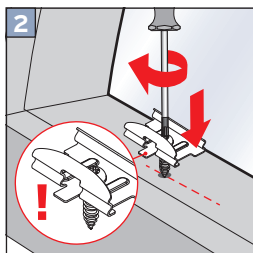
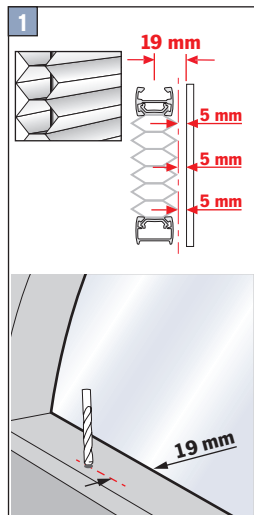
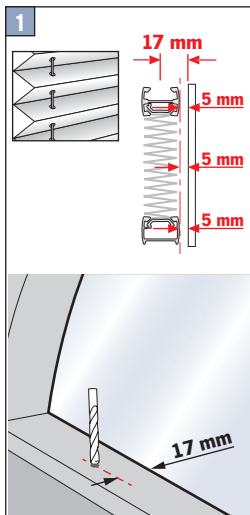
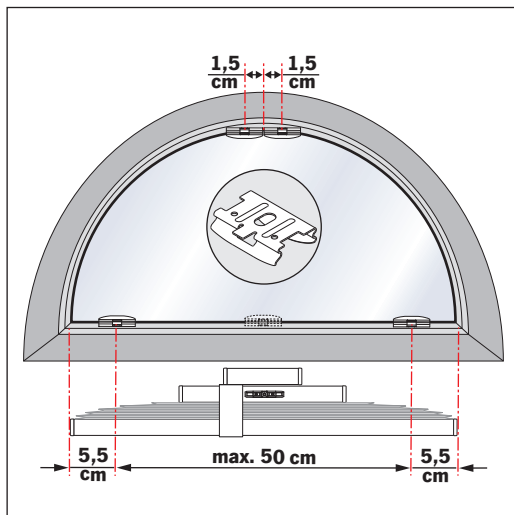

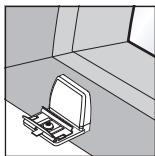

Winkelmontage  
 Face fixing  
 Montaż frontalny (nawierzchniowy)  
 Монтаж на проем

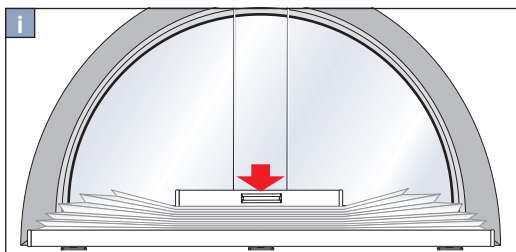
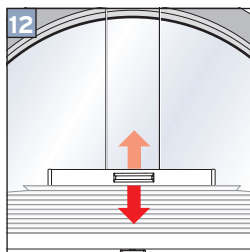
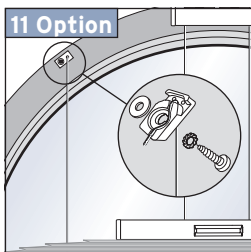
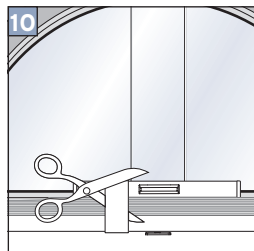
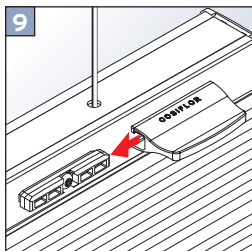
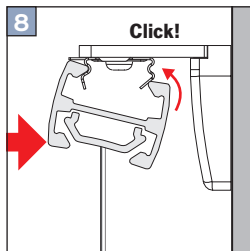
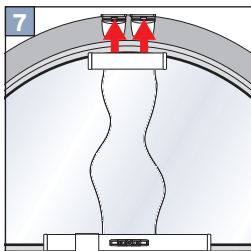
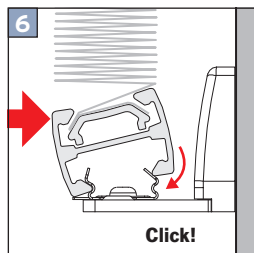
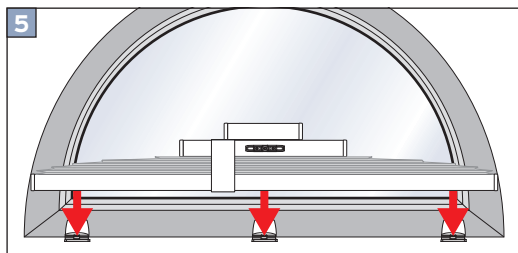
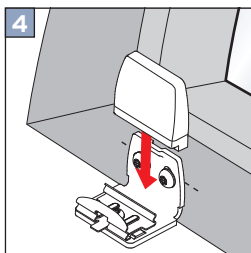
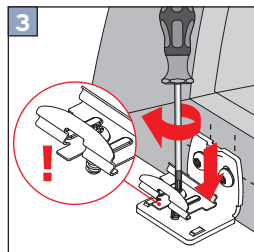
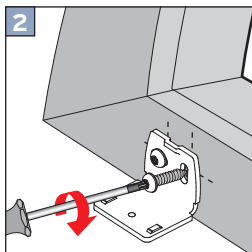
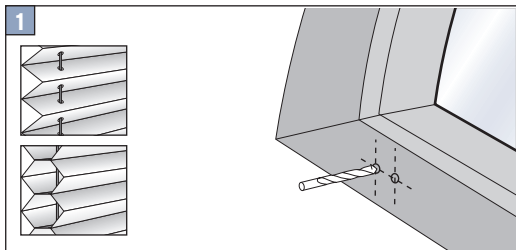
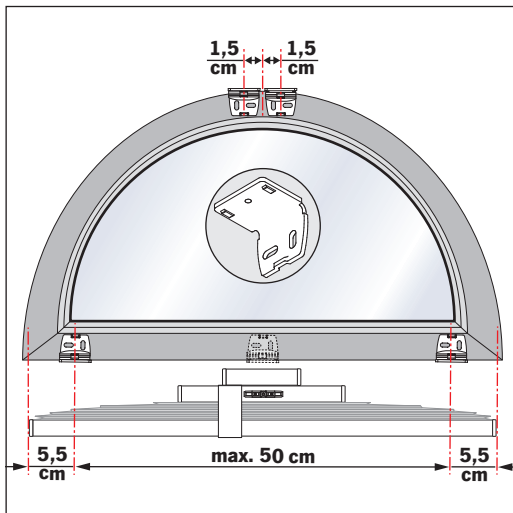

**Demontage • Disassembly • Demontaž • Демонтаж**

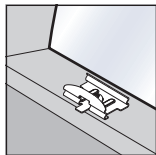

Falzmontage  
Top fixing  
Montaż w świetle szyby  
Монтаж в проем

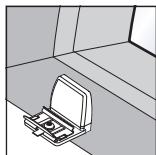
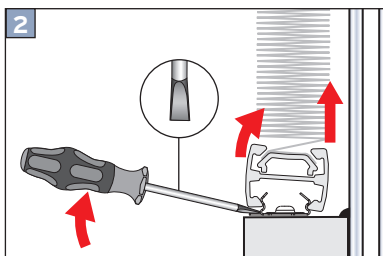
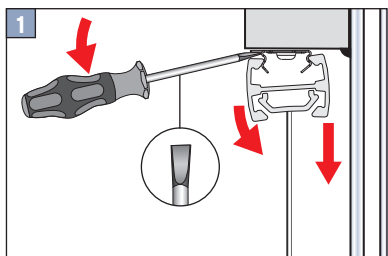

Winkelmontage  
Face fixing  
Montaż frontalny (nawierzchniowy)  
Монтаж на проем

